

Our small chain links, Kriska and Snina, are the authentic essence of Kriskadecor.

They make large projects a reality. They have an aluminium soul and dress up in colours to fit any occasion. They are so similar that they share all their qualities and possibilities.

The chain links

Los eslabones

La auténtica esencia de Kriskadecor son nuestras pequeñas piezas que dan vida a grandes proyectos: Kriska y Snina.

Con alma de aluminio, se visten de colores según lo requiera cada ocasión. Son muy parecidas, tanto que comparten todas sus cualidades y posibilidades.

Kriska

The durable and highly versatile star of the show. La gran protagonista, es resistente y muy versátil.

11,86 mm / 0.467" Width Anchura
23,20 mm / 0.315" Length Longitud
8,00 mm / 0.913" Depth Profundidad



Snina

Snina plays an important role if you are seeking definition and delicacy.

Snina juega un papel importante cuando se trata de buscar definición y delicadeza.

8,85 mm / 0.348" Width Anchura
15,7 mm / 0.252" Length Longitud
6,4 mm / 0.618" Depth Profundidad



We work with two different densities.
Depending on the type of project, the chains
can hang symmetrically or asymmetrically.

Densities

Densidades

Trabajamos con dos tipos de densidades.
Dependiendo del tipo de proyecto, las cadenas
pueden colgar de forma homogénea o asimétrica.

Standard

The perfect symmetry. Homogeneously aligned
rows of chains. Suitable for most uses.
La simetría perfecta. Líneas de cadena alineadas
de forma homogénea. Adecuada para la mayoría
de los usos.

Kriska

78 strands per linear metre of rail.
78 tiras por metro lineal de rail.

Snina

100 strands per linear metre of rail.
100 tiras por metro lineal de rail.

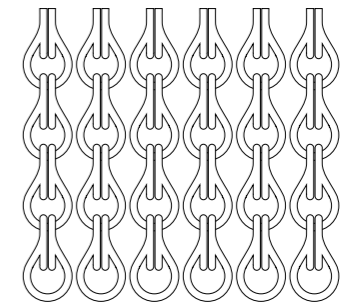

Half-drop

The asymmetrical option. For projects that
require higher opacity.
La opción asimétrica. Para proyectos que
requieren mayor opacidad.

Kriska

100 strands per linear metre of rail.
100 tiras por metro lineal de rail.

Snina

132 strands per linear metre of rail.
132 tiras por metro lineal de rail.

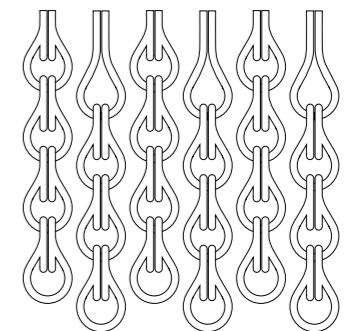

Kriska and Snina are chameleons! They feel at ease and look their best in elegant settings, where the colour black stands out, as well as in fun shop windows, where they attract all eyes. By combining their colours, you can create images and patterns of all kinds. Kriska and Snina are open to all possibilities, so you don't get bored of them.

Finishes and colours

Acabados y colores

Kriska y Snina son muy camaleónicas. Pueden sentirse cómodas y lucir en todo su esplendor tanto en un ambiente elegante, donde destaque el color negro, como en un divertido escaparate donde capten todas las miradas. Combinando sus colores puedes crear imágenes y patrones de todo tipo. Kriska y Snina están abiertas a todas las posibilidades para que no te aburras con ellas.

UPDATED COLOURS
COLORES ACTUALIZADOS



Anodised colours Colores anodizados

The colours of the final product may vary due to lighting effects or the catalogue printing process.
Los colores pueden no ajustarse a la realidad debido a efectos de iluminación o al proceso de impresión del catálogo.

BLACK NEGRO		GREY GRIS		COFFEE CAFÉ	
Brilliant Brillante 20011		Brilliant Brillante 20012		Brilliant Brillante 20021	
Satin Satinado 20211		Satin Satinado 20212		Satin Satinado 20221	
BROWN MARRÓN		SAND ARENA		APRICOT ALBARICOQUE	
Brilliant Brillante 20006		Brilliant Brillante 20028		Brilliant Brillante 20020	
Satin Satinado 20206		Satin Satinado 20228		Satin Satinado 20220	
ORANGE NARANJA		GOLD ORO		LIME LIMA	
Brilliant Brillante 20013		Brilliant Brillante 20003		Brilliant Brillante 20017	
Satin Satinado 20213		Satin Satinado 20203		Satin Satinado 20217	
EMERALD ESMERALDA		MOSS MUSGO		GREEN VERDE	
Brilliant Brillante 20008		Brilliant Brillante 20027		Brilliant Brillante 20004	
Satin Satinado 20208		Satin Satinado 20227		Satin Satinado 20204	
SILVER PLATA		NICKEL NICKEL		AMETHYST AMATISTA	
Brilliant Brillante 20001		Satin Satinado 20214		Brilliant Brillante 20026	
Satin Satinado 20201				Satin Satinado 20226	
PALE PINK ROSA PÁLIDO		PINK ROSA		FLORIDA PINK ROSA FLORIDA	
Brilliant Brillante 20024		Brilliant Brillante 20010		Brilliant Brillante 20016	
Satin Satinado 20224		Satin Satinado 20210		Satin Satinado 20216	
BORDEAUX BURDEOS		RED ROJO		LILAC LILA	
Brilliant Brillante 20018		Brilliant Brillante 20005		Brilliant Brillante 20007	
Satin Satinado 20218		Satin Satinado 20205		Satin Satinado 20207	
BLUE AZUL		COBALT COBALTO		TURQUOISE TURQUESA	
Brilliant Brillante 20002		Brilliant Brillante 20029		Brilliant Brillante 20009	
Satin Satinado 20202		Satin Satinado 20229		Satin Satinado 20209	

Lacquered colours Colores lacados

Outdoor: RAL colours tested under solar radiation. Other RAL colours may be possible upon request.

Interior: Available in all the colours on the RAL colour chart.

Exterior: Colores RAL testados bajo exposición solar. Otros colores RAL se valorarán bajo petición.

Interior: Disponibles todos los colores de la carta RAL.

BEIGE
BEIGE
RAL 1001



BROWN BEIGE
BEIGE PARDO
RAL 1011



LIGHT IVORY
MARFIL CLARO
RAL 1015



GREY BEIGE
BEIGE GRIS
RAL 1019



TRAFFIC YELLOW
AMARILLO TRÁFICO
RAL 1023



PEARL BEIGE
BEIGE PERLADO
RAL 1035



PURPLE RED
ROJO PÚRPURA
RAL 3004



RASPBERRY RED
ROJO FRAMBUESA
RAL 3027



RED LILAC
ROJO LILA
RAL 4001



TRAFFIC PURPLE
PÚRPURA TRÁFICO
RAL 4006



SIGNAL VIOLET
VIOLETA SEÑALES
RAL 4008



SIGNAL BLUE
AZUL SEÑALES
RAL 5005



AZURE BLUE
AZUL AZUR
RAL 5009



PIGEON BLUE
AZUL COLOMBINO
RAL 5014



SKY BLUE
AZUL CELESTE
RAL 5015



CAPRI BLUE
AZUL CAPRI
RAL 5019



WATER BLUE
AZUL AGUA
RAL 5021



PASTEL BLUE
AZUL PASTEL
RAL 5024



LEAF GREEN
VERDE HOJA
RAL 6002



RESEDA GREEN
VERDE RESEDA
RAL 6011



YELLOW GREEN
VERDE AMARILLENTO
RAL 6018



PASTEL GREEN
VERDE BLANQUECINO
RAL 6019



OPAL GREEN
VERDE ÓPALO
RAL 6026



LIGHT GREEN
VERDE LUMINOSO
RAL 6027



The colours of the final product may vary due to lighting effects or the catalogue printing process.

Los colores pueden no ajustarse a la realidad debido a efectos de iluminación o al proceso de impresión del catálogo.

MINT TURQUOISE
TURQUESA MENTA
RAL 6033



OLIVE GREY
GRIS OLIVA
RAL 7002



MOSS GREY
GRIS MUSGO
RAL 7003



BEIGE GREY
GRIS BEIGE
RAL 7006



GREEN GREY
GRIS VERDOSO
RAL 7009



TARPAULIN GREY
GRIS LONA
RAL 7010



BRONW GREY
GRIS PARDUZCO
RAL 7013



UMBRA GREY
GRIS SOMBRA
RAL 7022



PEBBLE GREY
GRIS GUIJARRO
RAL 7032



QUARTZ GREY
GRIS QUARZO
RAL 7039



WINDOW GREY
GRIS VENTANA
RAL 7040



SILK GREY
GRIS SEDA
RAL 7044



PEARL MOUSE GREY
GRIS MUSGO PERLADO
RAL 7048



OLIVE BROWN
PARDO OLIVA
RAL 8008



TERRA BROWN
MARRÓN TIERRA
RAL 8028



GREY WHITE
BLANCO GRISÁCEO
RAL 9002



SIGNAL WHITE
BLANCO SEÑALES
RAL 9003



JET BLACK
NEGRO INTENSO
RAL 9005



WHITE ALUMINIUM
ALUMINIO BLANCO
RAL 9006



PURE WHITE
BLANCO PURO
RAL 9010



GRAPHITE BLACK
NEGRO GRAFITO
RAL 9011



PEARL LIGHT GREY
GRIS CLARO PERLADO
RAL 9022



PEARL DARK GREY
GRIS OSCURO PERLADO
RAL 9023



Each project is unique, so we provide a customised solution for each idea.

Custom-made Hecho a medida

Cada proyecto es único, por eso cada idea obtiene una solución hecha a su medida.

Measurements Medidas

During the project development phase, our clients' specifications are followed rigorously.
Durante el desarrollo del proyecto, se siguen cuidadosamente las especificaciones de nuestros clientes.

SMALL STRUCTURES ESTRUCTURAS PEQUEÑAS



LARGE STRUCTURES ESTRUCTURAS GRANDES



Shapes and volumes

Formas y volúmenes

From simple applications to sculptural pieces. Our chains and fixing options enable us to adapt to all kinds of geometric, organic, or abstract shapes.
 Desde aplicaciones sencillas hasta piezas escultóricas. Nuestras cadenas y sistemas de fijación nos permiten adaptarnos a todo tipo de formas geométricas, orgánicas o abstractas.

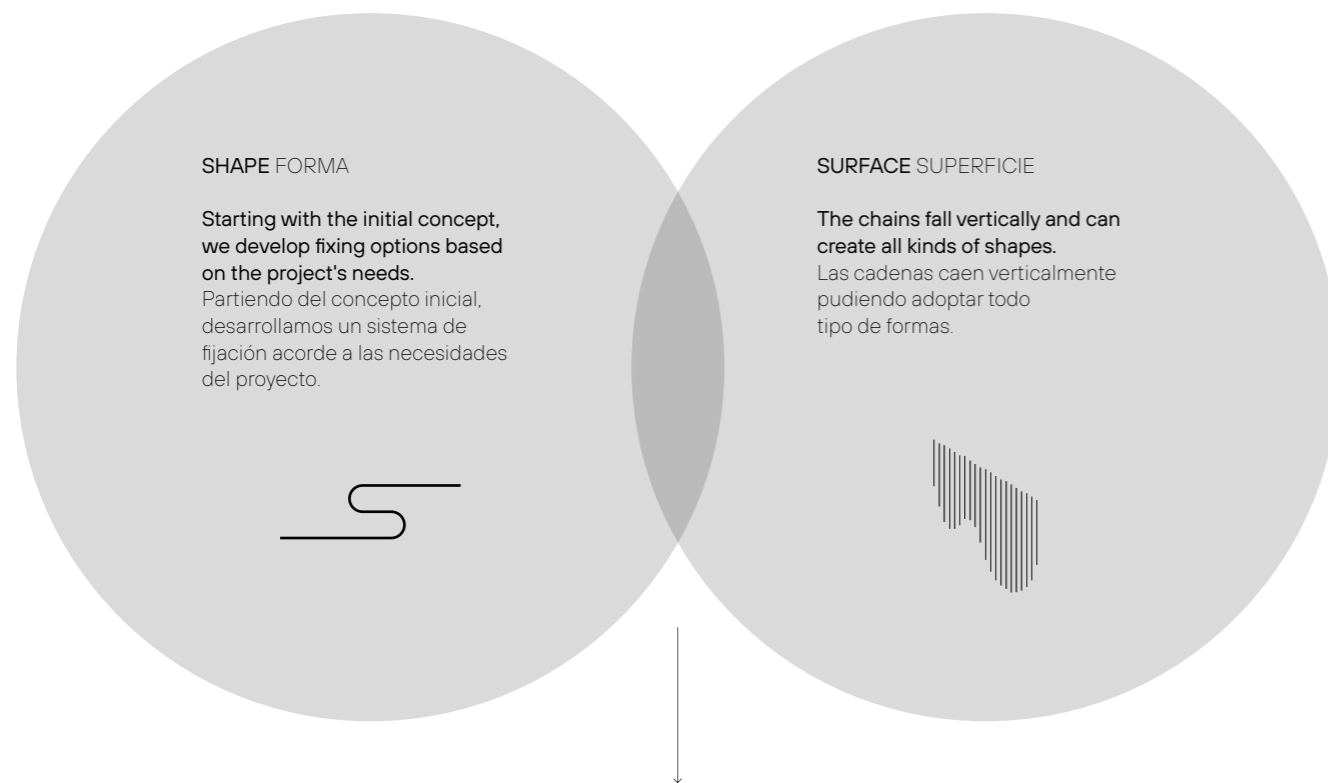

SHAPE FORMA

Starting with the initial concept, we develop fixing options based on the project's needs.
 Partiendo del concepto inicial, desarrollamos un sistema de fijación acorde a las necesidades del proyecto.

SURFACE SUPERFICIE

The chains fall vertically and can create all kinds of shapes.
 Las cadenas caen verticalmente pudiendo adoptar todo tipo de formas.

VOLUME VOLUMEN

It allows the combination of different densities, chain lengths and chain shaping, offering a total customisation of spaces.
 Permite combinar diferentes densidades, longitudes de cadena y vaciados, ofreciendo una total personalización de los espacios.

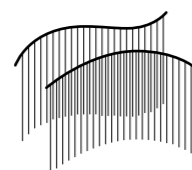

Image reproduction

Reproducción de imágenes

We have developed our own in-house technology to generate images, patterns, or corporate logos, in which each chain link acts as a pixel.
 Hemos desarrollado una tecnología propia con la que podemos generar imágenes, patrones o logotipos corporativos, en los que cada eslabón de la cadena actúa como un píxel.

- 1 Our clients provide us with an image, design, or logo that they want to reproduce.
 El cliente nos proporciona la imagen, diseño o logotipo que desea reproducir.
- 2 We pixelate it using our own software, and our designers hand-retouch it to 'weave' it as accurately as possible.
 Lo pixelamos mediante un software propio y nuestros diseñadores lo retocan manualmente para "tejerlo" con la mayor precisión posible.
- 3 We add the profiles needed to leave it installation ready.
 Incorporamos los perfiles necesarios, dejando el diseño listo para instalar.



Our fixing options combine design and technology to offer an optimal installation solution according to the project's needs.

Fixing options

Sistemas de fijación

Nuestros sistemas de fijación combinan diseño y tecnología, ofreciendo una solución óptima de montaje según las necesidades del proyecto.

FIXING OPTIONS
SISTEMAS DE FIJACIÓN



40x3

BY ROGER VANCELLS

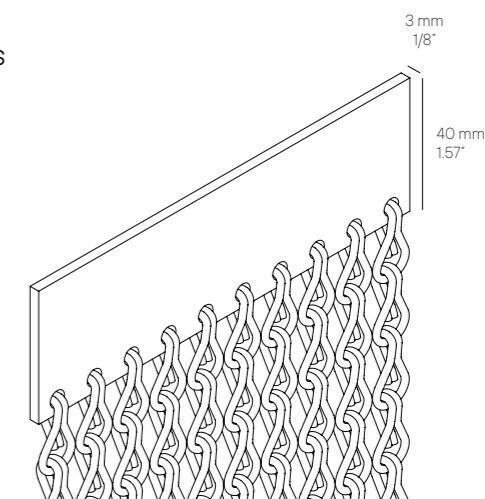

INSTALLATION OPTIONS OPCIONES DE INSTALACIÓN

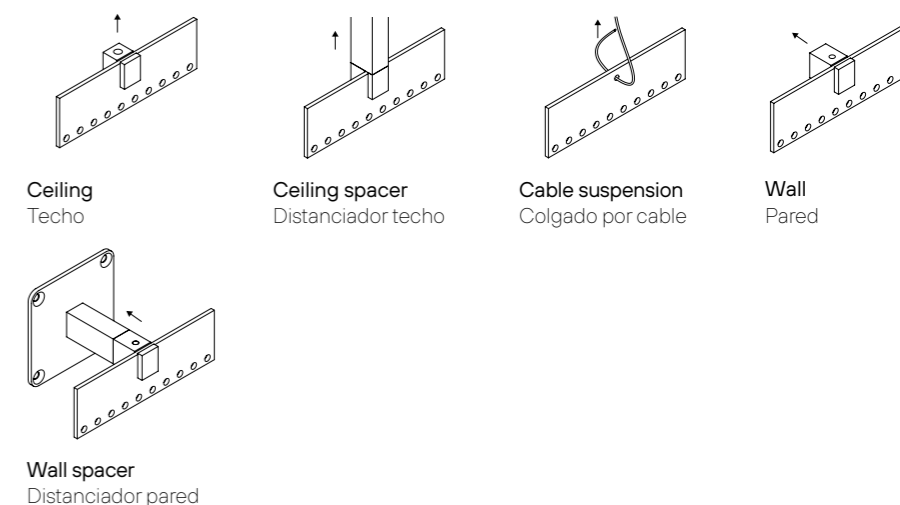

FITTINGS UNIONES

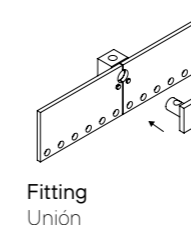

UNDULATION ONDULACIÓN

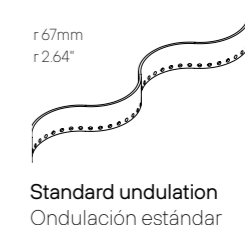

Light rail suitable for both straight and curved shapes. Ideal como ligera guía de soporte, adaptable a formas lineales y curvas.

SHAPES FORMAS

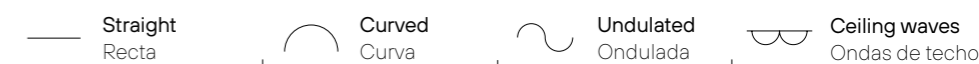

SYSTEM SISTEMA

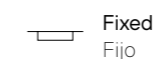

FINISHES ACABADOS

Anodised aluminium / Aluminio anodizado
Custom RAL colour / Color custom RAL

*Cables not supplied.
*No se suministran los cables.

SLIM

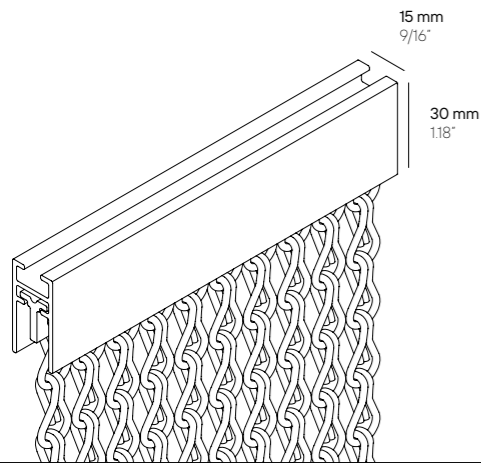

INSTALLATION OPTIONS OPCIONES DE INSTALACIÓN

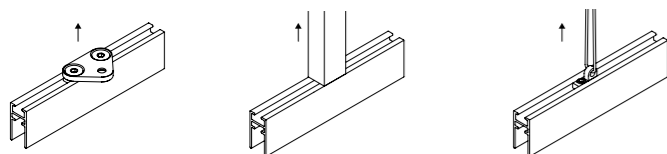

Ceiling Techo
Ceiling spacer Distanciator techo
Cable suspension Colgado por cable

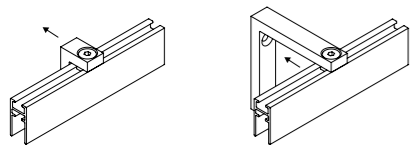

Wall Pared
Wall spacer Distanciator pared

FITTINGS UNIONES

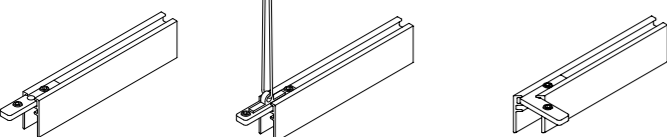

Fitting Unión
Fitting for cable suspension Unión con cable
90° fitting Unión 90°

Rectangular and discreet, this is the ideal solution for projects where the rail doesn't need to stand out.
De forma rectangular y muy sobria, es la solución idónea para proyectos en los que la guía no requiere de ningún protagonismo.

SYSTEM SISTEMA



Fixed Fijo

SHAPES FORMAS



Straight Recta
Curved Curva
Ceiling waves Ondas de techo

FINISHES ACABADOS

Anodised aluminium Aluminio anodizado
Custom RAL colour Color custom RAL

MINIOVAL

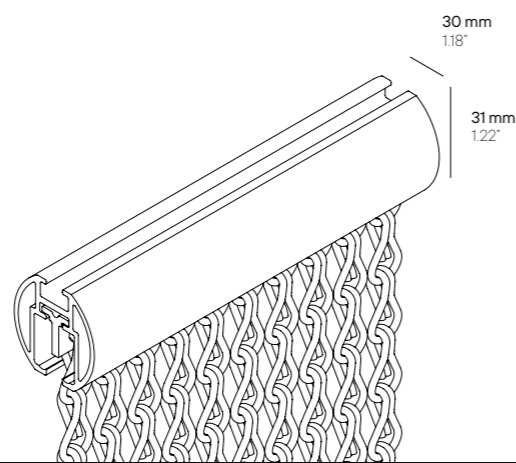

INSTALLATION OPTIONS OPCIONES DE INSTALACIÓN

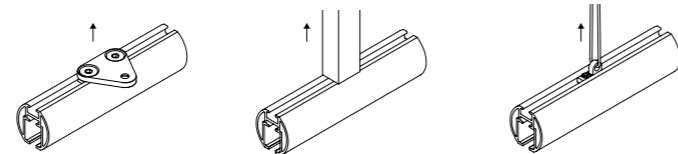

Ceiling Techo
Ceiling spacer Distanciator techo
Cable suspension Colgado por cable

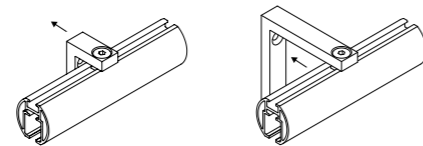

Wall Pared
Wall spacer Distanciator pared

FITTINGS UNIONES

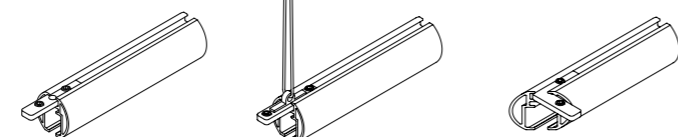

Fitting Unión
Fitting for cable suspension Unión con cable
90° fitting Unión 90°

Tubular rail suitable for both straight and curved shapes.
Perfil de forma tubular que se adapta a líneas rectas o curvas.

SYSTEM SISTEMA



Fixed Fijo

SHAPES FORMAS



Straight Recta
Curved Curva
Ceiling waves Ondas de techo

FINISHES ACABADOS

Anodised aluminium Aluminio anodizado
Custom RAL colour Color custom RAL

*Cables not supplied.
*No se suministran los cables.

QUAD Traversing

BY ROGER VANCELLS

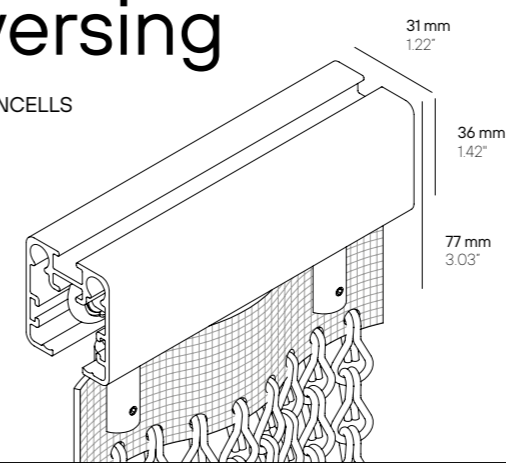

INSTALLATION OPTIONS OPCIONES DE INSTALACIÓN

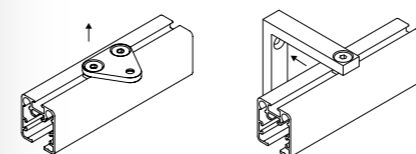

Ceiling Techo
Wall Pared

FITTINGS UNIONES

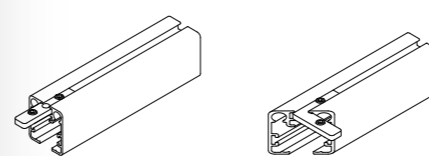

Fitting Unión
90° fitting Unión 90°

UNDULATED ONDULADO



GATHERED FRUNCIDO

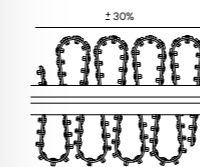

30% gathering over total length
30% de fruncido sobre la longitud total

Profile system that comes with a textile tape to allow the movement of the chains. The tape can create a flat or wavy effect, depending on the project's needs. Adaptable to straight or curved compositions.
Sistema que integra una cinta para dar movilidad a las cadenas. La cinta nos permite crear un efecto plano u onda wave según las necesidades del proyecto. Adaptable a composiciones lineales o curvas.

SYSTEM SISTEMA

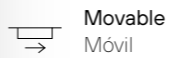

Movable Móvil

SHAPES FORMAS

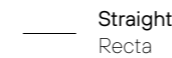

Straight Recta

FINISHES ACABADOS

Anodised aluminium Aluminio anodizado
Custom RAL colour Color custom RAL

QUAD Sliding

BY ROGER VANCELLS

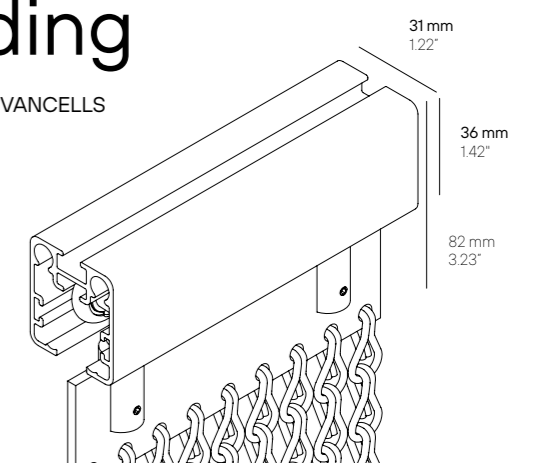

INSTALLATION OPTIONS OPCIONES DE INSTALACIÓN

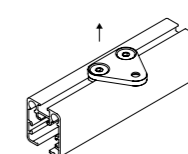

Ceiling Techo

FITTINGS UNIONES

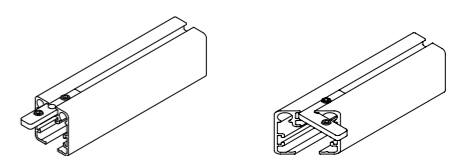

Fitting Unión
90° fitting Unión 90°

Movable profile system with slide rails that allow a 'panel' effect.
Sistema de perfil móvil con guías que permite la creación del efecto "paneles".

SYSTEM SISTEMA

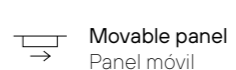

Movable panel Panel móvil

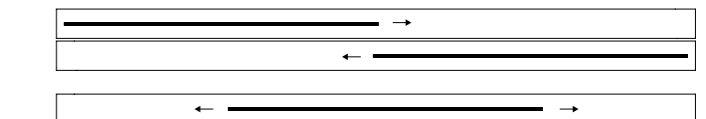

SHAPES FORMAS

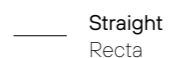

Straight Recta

FINISHES ACABADOS

Anodised aluminium Aluminio anodizado
Custom RAL colour Color custom RAL

BCN TENSED & FRAMED SYSTEM

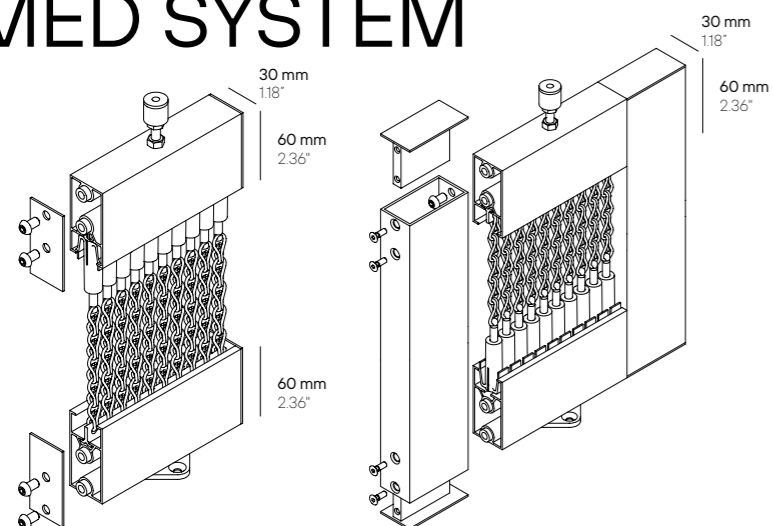

INSTALLATION OPTIONS OPCIONES DE INSTALACIÓN

FRAMED ENMARCADO

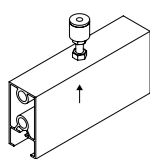

Ceiling and floor
Techo y suelo

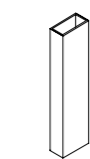
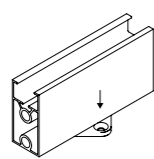

Side profile
Perfil lateral

FITTINGS UNIONES

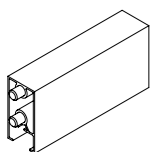

Fitting
Unión

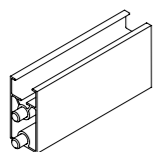

TAUT SYSTEM LENGTHWISE OR FRAMED SISTEMA TENSADO LONGITUDINAL O ENMARCADO

Floor and ceiling fastening profile with a spring system on the upper part to guarantee the stability of the chains.

Perfil de fijación a suelo y techo que incorpora un sistema de muelles en la parte superior para garantizar la estabilidad de las cadenas.

SYSTEM SISTEMA

SHAPES FORMAS

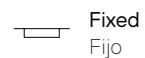

Fixed
Fijo

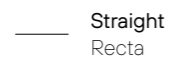

Straight
Recta

FINISHES ACABADOS

Custom RAL colour
Color custom RAL

CLADDING Outdoor

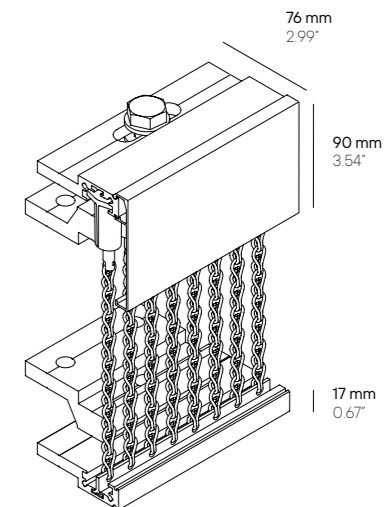

SYSTEM COMPONENTS COMPONENTES DEL SISTEMA

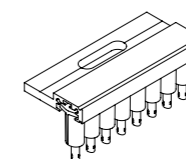

Top fastening
Fijación superior

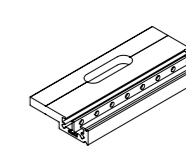

Bottom fastening
Fijación inferior

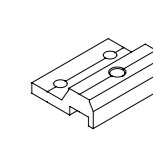

Regulator
Regulador

ACCESSORIES COMPLEMENTOS

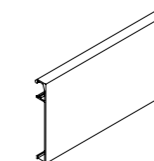

Cover
Embellecedor

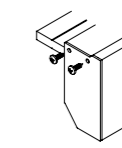

Side lid
Tapa lateral

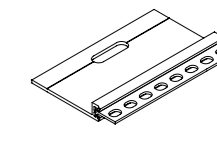

Movement limiter
Limitador de movimiento

BRACKETS ANCLAJES

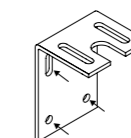

Wall
Pared

The KDC Thin System is specially designed to cover large outdoor surfaces with all the guarantees and maximum quality. Each project is fully customisable in size, shape, and design.

El sistema KDC Thin System está especialmente diseñado para cubrir grandes superficies exteriores con todas las garantías y la máxima calidad. Cada proyecto es totalmente personalizable en tamaño, forma y diseño.

SYSTEM SISTEMA

SHAPES FORMAS

FINISHES ACABADOS

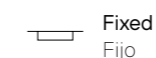

Fixed
Fijo



Straight
Recta

Custom RAL colour
Color custom RAL

VOLUME

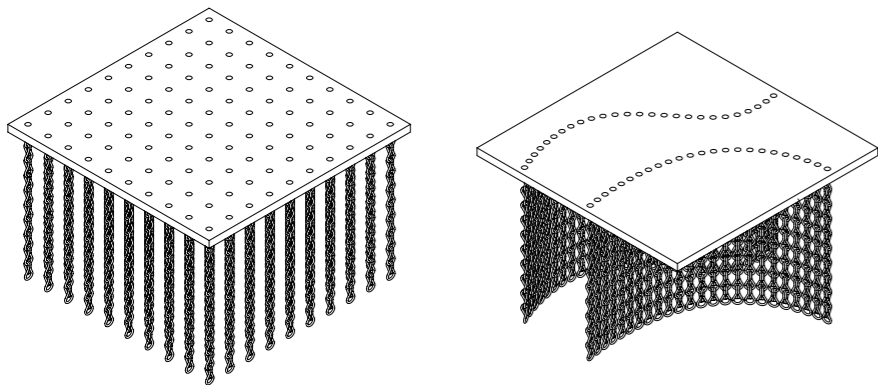

METAL PANEL PANEL METÁLICO

The metal panel for ceilings is a lightweight option that offers many possibilities to customise the space.

El panel metálico para techos es una opción ligera que ofrece múltiples opciones de personalización del espacio.

ACOUSTIC PANEL PANEL ACÚSTICO

Perforated wooden panel that absorbs sound and lowers reverberations, improving the acoustic qualities of any room.

Panel de madera perforada que absorbe el sonido y reduce la reverberación, mejorando la calidad acústica de cualquier tipo de sala.

INSTALLATION OPTIONS OPCIONES DE INSTALACIÓN



Ceiling

Techo

CEILING DECORATION DECORACIÓN DE TECHO

Structure that allows a combination of different densities, shapings and chain lengths. It offers a complete customisation of spaces to achieve surprising effects and volumes with colours and patterns. Estructura que permite combinar diferentes densidades, vaciados y longitudes de cadena, ofreciendo una total personalización de los espacios para lograr efectos y volúmenes sorprendentes mediante colores y patrones.

SYSTEM SISTEMA

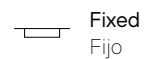

Fixed

Fijo

VOLUMES VOLÚMENES

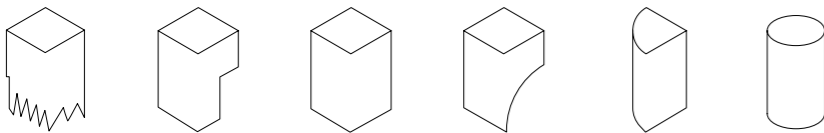

+ Others
+ Otros

FINISHES ACABADOS

Custom RAL colour
Color custom RAL

OTHER OPTIONS OTRAS OPCIONES

In addition to our standard profiles and fixing options, we also offer other solutions that create unique finishes.

Además de nuestros perfiles y sistemas de fijación estándar, ofrecemos otras opciones que permiten conseguir acabados menos habituales.

CHAIN LINKING ANILLADO

The chains can be linked with rings at any height. This option brings rigidity to simulate a fabric and prevents people from going through them. Las cadenas se pueden enlazar entre sí mediante anillas a cualquier altura. Esta opción aporta rigidez, simulando un tejido y evitando el paso a través de ellas.

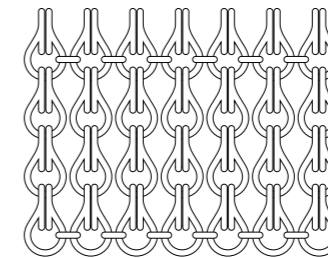

SHAPING VACIADO

Cutting the surface of the chains following straight or curved lines creates surprising effects. The chain can be framed or left free to move. El recorte de la superficie de las cadenas siguiendo líneas rectas o curvas permite crear efectos sorprendentes. La cadena puede enmarcarse o quedar libre de movimiento.

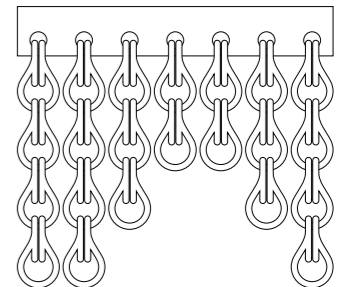

BOTTOM FIXING FIJACIÓN INFERIOR

To prevent the strands from moving, they can be fixed to the floor.

Para evitar que las tiras puedan moverse, es posible fijarlas al suelo.

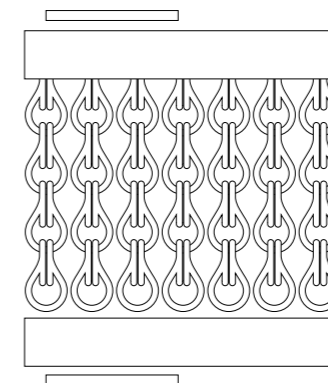

Discover all the technical features of our anodised aluminium chains to ensure a perfect fit with your project.

Technical specifications

Especificaciones técnicas

Descubre todas las características técnicas de las cadenas de aluminio anodizado para una mejor adaptación a tu proyecto.

Thickness

Thickness of the aluminium wire:
Kriska 2 mm / .0787" and Snina 1.5 mm / .0591".

Static load

Maximum static breaking load:
Kriska 17 kg / 37.5 lbs and Snina 11 kg / 24 lbs (approx.).

Material

Anodised aluminium chain with an 8.5 and 12 microns thick coating depending on the colour and finish.

Composition

 Material made of 99.99% aluminium.

Appearance

Soft appearance. Imperceptible roughness.

Opacity

Opacity between 40% and 60% with an angle of inclination of 90°, depending on spacing and finishing (brilliant or satin).

Conductivity

 Does not conduct electricity.

Acoustics

 No sound absorption

Fire-resistance

 A1-rated product (non-combustible).
USA CA Title 19 certificate.

Cleaning

 Resistant to acidic products with pH below 8 (not alkaline products).

Rust

 Rust-resistant.

Temperature

 Recommended working temperature: -30°C / -22° F up to 50°C / +122° F.

Impermeability

 Resistant to sea water.

Weight

 Kriska standard: 3.03 kg / 12 oz. Kriska Half-drop: 3.88 kg / 15 oz.
Snina standard: 2.25 kg / 8 oz. Snina Half-drop: 2.96 kg / 11 oz

Grosor

Grosor del hilo de aluminio:
Kriska 2 mm / .0787" y Snina 1,5 mm / .0591".

Carga estática

Carga estática máxima sin rotura:
Kriska 17 kg / 37.5 lbs y Snina 11 kg / 24 lbs (aprox.).

Material

Cadena de aluminio anodizado con recubrimiento de entre 8,5 y 12 micras, dependiendo del color y acabado.

Composición

 Material compuesto por un 99,99% de aluminio.

Aspecto

Acabado suave. Rugosidad imperceptible.

Opacidad

Opacidad entre 40% y 60% con un ángulo de inclinación de 90°, dependiendo del espaciado y el acabado (brillo o satinado).

Conductividad

 No conduce la electricidad.

Acústica

 No absorbe sonido.

Resistencia al fuego

 Clasificación A1 de resistencia al fuego (no inflamable).
USA CA Title 19 certificate.

Limpieza

 Resistente a productos ácidos de pH inferior a 8 (no a productos alcalinos).

Oxidación

 Resistente a la oxidación.

Temperatura

 Temperatura recomendada de trabajo: -30°C / -22° F hasta 50°C / +122° F.

Impermeabilidad

 Resistente al agua de mar.

Peso

 Kriska estándar: 3.03 kg / 12 oz. Kriska Half-drop: 3.88 kg / 15 oz.
Snina estándar: 2.25 kg / 8 oz. Snina Half-drop: 2.96 kg / 11 oz

Creativity should have the chance to materialise.
Do you need to know how to take measurements
or maintain our chains properly?
Find it out in this section.

Practical information Información práctica

La creatividad debe poder materializarse.
¿Necesitas saber cómo tomar medidas o el
mantenimiento necesario de nuestras cadenas?
Te lo explicamos en este apartado.

Project measurements Medidas del proyecto

- Projects can have any size in terms of both height and width.
- The material is supplied according to the measurements provided by the client.
- They should always include the rail and the fixing system.
- Due to the size of the links and the separation between them, the measurements may not be exact, although they will be close to the height and width requested, without exceeding them, as much as technically possible.
- Los proyectos pueden ser de cualquier dimensión, tanto en altura como en anchura.
- El material se suministra según las medidas indicadas por el cliente. Estas siempre incluyen el rail y el sistema de fijación.
- Debido al tamaño de los eslabones y a la separación entre tiras, las medidas pueden no ser exactas, aunque se aproximarán tanto como sea técnicamente posible a la altura y anchura solicitadas, sin sobrepasarlas.

Installation Instalación

- Installation is simple and doesn't require specialised personnel, but you do have to check that the structure where the chains will be installed can bear their weight.
- To achieve the best effect with the chain, we recommend leaving 2 cm (3/4") free at the bottom.
- La instalación es sencilla y no precisa de personal especializado, pero es necesario comprobar que la estructura donde se instalará la cadena resiste su peso.
- Para conseguir un mejor efecto de la cadena, recomendamos dejar libres 2 cm (3/4") en la parte inferior.

Cleaning and maintenance Limpieza y mantenimiento

- Aluminium is a very light and easy to handle material.
- In terms of the cleaning protocol, the chain can be washed and disinfected using two processes to keep its finish intact:
 1. With water and detergent (pH up to 8) and then spraying with an alcohol and water solution (70-30%).
 2. With steam cleaners, if you want to avoid chemical agents.
- El aluminio es un elemento muy ligero y de fácil manipulación.
- En cuanto al protocolo de limpieza, la cadena puede lavarse y desinfectarse mediante dos procesos que respetan su acabado:
 1. Con agua y detergente (pH hasta 8) y posterior rociado con una solución de alcohol y agua (70-30%).
 2. Con limpiadoras al vapor si se quieren evitar agentes químicos.

Kriska and Snina are made of aluminium.
They are lightweight and resistant.

Aluminium

El aluminio

Kriska y Snina están hechas de aluminio.
Son ligeras y resistentes.

Our products are manufactured in our facilities from start to finish: from manufacturing the link chains with aluminium wire to the structures installed in each project. Our chain links are made of 99.99% aluminium and are subject to a special anodised treatment that makes them harder, and grants their colour a higher resistance to climate factors, friction, and rust.

THEY ARE waterproof, odourless, and good light receptors.
THEY ARE NOT magnetic or toxic.

Nuestros productos se fabrican de principio a fin en nuestras instalaciones: desde la elaboración de las cadenas de eslabones a partir de alambre de aluminio, hasta las estructuras que se acaban instalando en cada proyecto. Nuestros eslabones están compuestos por un 99,99% de aluminio y sometidos a un tratamiento de anodizado especial que les proporciona una mayor dureza y resistencia del color a los factores climáticos, así como al rozamiento y a la oxidación.

SON impermeables e inodoros y buenos receptores de la luz.
NO SON magnéticos ni tóxicos.

We develop sustainable solutions to minimise the environmental impact.

Sustainability Sostenibilidad

Desarrollamos soluciones sostenibles para minimizar el impacto en el medio ambiente.

Our goal at Kriskadecor is to minimise as much as possible our environmental impact, investing resources and effort to that end.

Our links are 99.99% aluminium, of which 20% is recycled. Therefore, their production requires fewer resources and reduces our carbon footprint. And best of all, it's a metal with infinite recycling cycles. Aluminium is our main raw material, so we help promote the circular economy thanks to its high recyclability with no quality loss. Moreover, its recycling reduces energy consumption by 95% compared to the bauxite extraction process, the main source of aluminium in the world.

Currently, the construction industry recycles between 92% and 98% of aluminium. It's estimated that around 75% of the aluminium recycled in the past 100 years is still in use. In addition, this metal has outstanding properties for both interior design and architecture because it's fireproof, it doesn't rust and it's lighter and more resistant than other materials.

As befitting a company committed to caring for the environment, we comply with the 3R rule: reduce, reuse, and recycle. In our production processes, we reuse water, minimising this resource's consumption.

Likewise, we contribute to the struggle against climate change, avoiding CO2 emissions and other polluting gases by using 100% green renewable energy.

En Kriskadecor tenemos el objetivo de minimizar al máximo nuestro impacto en el medio ambiente, invirtiendo recursos y esfuerzos en ello. Nuestros eslabones están hechos con un 99,99% de aluminio que, además, incorpora un 20% de material reciclado, por lo que su producción consume menos recursos para reducir nuestra huella de carbono. Y lo mejor, este metal tiene ciclos infinitos de reciclado. Como el aluminio es nuestra principal materia prima, ayudamos a promover la economía circular gracias a su gran capacidad de reciclado sin perder su calidad original. De hecho, su reciclado reduce el consumo energético en un 95% en comparación con el proceso de extracción de la bauxita, principal fuente de aluminio del mundo.

Actualmente, en el sector de la construcción se recicla entre un 92% y un 98% de aluminio y se estima que un 75% del aluminio reciclado en los últimos 100 años sigue en uso. Además, este metal tiene unas propiedades inmejorables tanto para el interiorismo como la arquitectura, ya que es ignífugo, no se oxida y es más ligero y resistente que otros materiales.

Como empresa comprometida con el cuidado del medio ambiente, cumplimos la ley 3R: reducir, reciclar y reutilizar. De hecho, dentro de nuestros diferentes procesos de producción, se reutiliza el agua para minimizar el uso de este recurso.

Asimismo, contribuimos a la lucha contra el cambio climático, evitando las emisiones de CO2 y otros gases contaminantes mediante la utilización de energía renovable 100% verde.

