

kriskadecor®  
linking  
ideas

# PRINT COLLECTION



Organic, figurative or symmetric patterns that fit in every ambient. In cold and heat colours. Kriskadecor presents its Print Collection designed by Claire Davies.



Diseños orgánicos, figurativos o simétricos para encajar en cualquier ambiente. En colores fríos y cálidos. Kriskadecor presenta su Colección de diseños estampados diseñados por Claire Davies.



## TABLE OF CONTENTS



## 6 ORGANIC

---

- Nieva de Noche / On Fire	4
- Earth	5
- Chessy	6
- Stripy Thing	7
- Persia Gold	7
- Stripes	8
- Sea / Fire Brush Strokes	9
- Lime / Pink Hippy Colorini	10

## 13 FIGURATIVE

---

- Skull & Bones	11
- Botti Black & White	12
- Botti	13
- Mint Lotus / Half Mint Lotus	13

## 16 GEOMETRIC

---

- Criss Cross	14
- Stripes	15
- Balsdosa Blue / Soft Pink	16
- Explosion	17
- Woody	17
- Big Kaleidoscope / Kaleidoscope	18

## 21 TECHNICAL INFO

---

- Maintenance and technical information	19
---	----

**NIEVA DE NOCHE**

Ref. DEC11022  
SNINA / KRISKA  
0,90 x 2,50 m  
1,35 x 2,50 m  
1,80 x 2,50 m

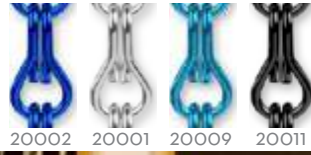

**ON FIRE**

Ref. DEC11003  
SNINA / KRISKA  
0,90 x 2,50 m  
1,35 x 2,50 m  
1,80 x 2,50 m





**EARTH**

Ref. DEC11034  
 KRISKA / SNINA  
 0,90 x 2,50 m  
 1,35 x 2,50 m  
 1,80 x 2,50 m



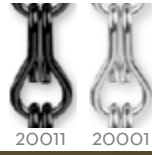

**CHEESY  
BLACK**  
Ref. DEC11007  
KRISKA  
1,35 x 2,50 m



**CHEESY  
DARK BROWN**  
Ref. DEC11040  
KRISKA  
1,35 x 2,50 m



**CHEESY  
GOLD**  
Ref. DEC11008  
KRISKA  
1,35 x 2,50 m



**CHEESY  
SILVER**  
Ref. DEC11037  
KRISKA  
1,35 x 2,50 m



**STRIPY THING**

Ref. DEC11026  
 KRISKA / SNINA  
 0,90 x 2,50 m  
 1,35 x 2,50 m  
 1,80 x 2,50 m

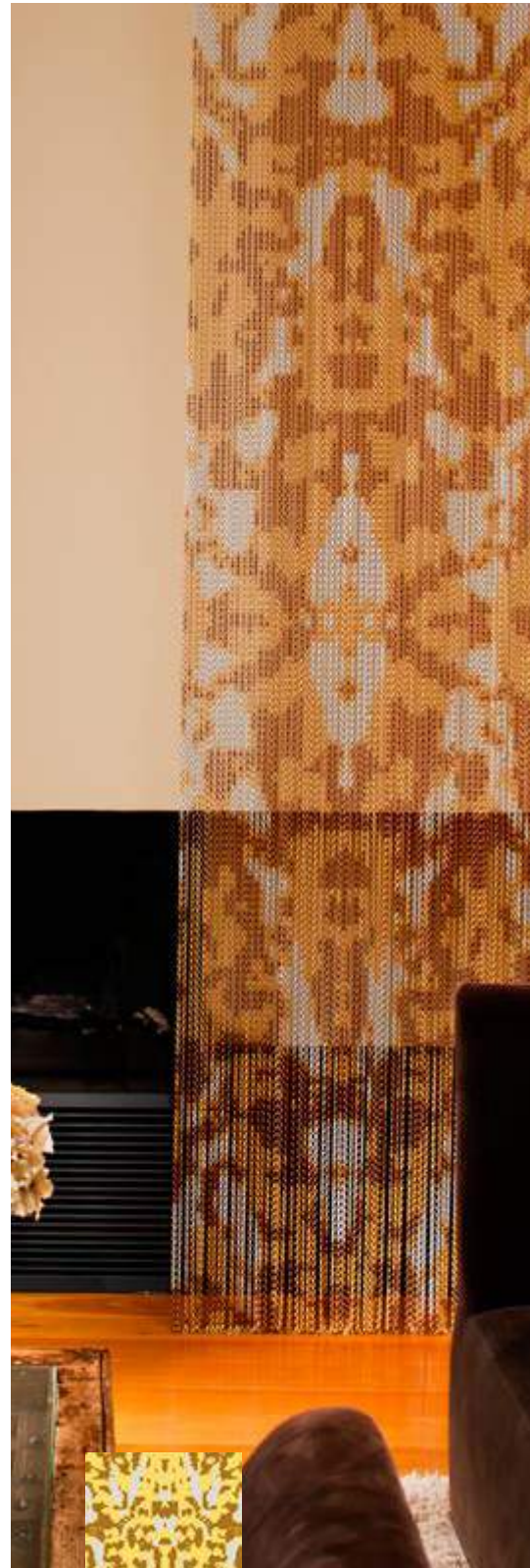

**PERSIA GOLD**

Ref. DEC11010  
 SNINA / KRISKA  
 0,90 x 2,50 m  
 1,80 x 2,50 m

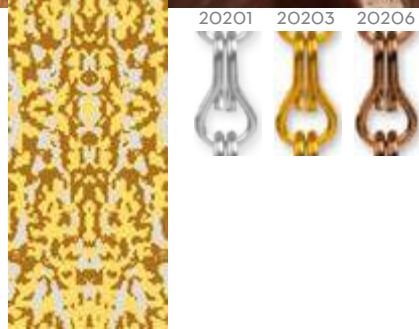

**STRIPES**

Ref. DEC11036  
KRISKA / SNINA  
0,90 x 2,50 m  
1,35 x 2,50 m  
1,80 x 2,50 m







**FIRE BRUSH STROKES**  
 Ref. DEC11025  
 KRISKA / SNINA  
 0,90 x 2,50 m  
 1,35 x 2,50 m  
 1,80 x 2,50 m



**SEA BRUSH STROKES**  
 Ref. DEC11024  
 KRISKA / SNINA  
 0,90 x 2,50 m  
 1,35 x 2,50 m  
 1,80 x 2,50 m

**PINK HIPPI  
COLORINI**

Ref. DEC11029  
KRISKA / SNINA  
0,90 x 2,50 m  
1,35 x 2,50 m  
1,80 x 2,50 m



**LIME HIPPI  
COLORINI**

Ref. DEC11027  
KRISKA / SNINA  
0,90 x 2,50 m  
1,35 x 2,50 m  
1,80 x 2,50 m



**SKULL & BONES**

Ref. DEC11018

SNINA

1,80 x 1,75 m

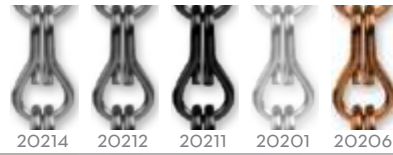

FIGURATIVE



**BOTTI**  
**BLACK & WHITE**  
Ref. DEC11015  
KRISKA / SNINA  
1,80 x 2,50 m



FIGURATIVE



**BOTTI**  
 Ref. DEC11001  
 SNINA  
 1,80 x 2,50 m



FIGURATIVE



**HALF MINT LOTUS**  
 Ref. DEC11020  
 KRISKA  
 0,90 x 2,50 m

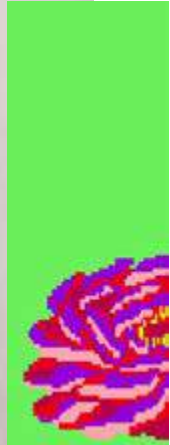

**MINT LOTUS**  
 Ref. DEC11021  
 KRISKA  
 1,80 x 2,50 m

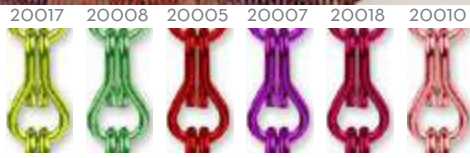

**CRISS CROSS**

Ref. DEC11017  
KRISKA / SNINA  
1,80 x 2,50 m

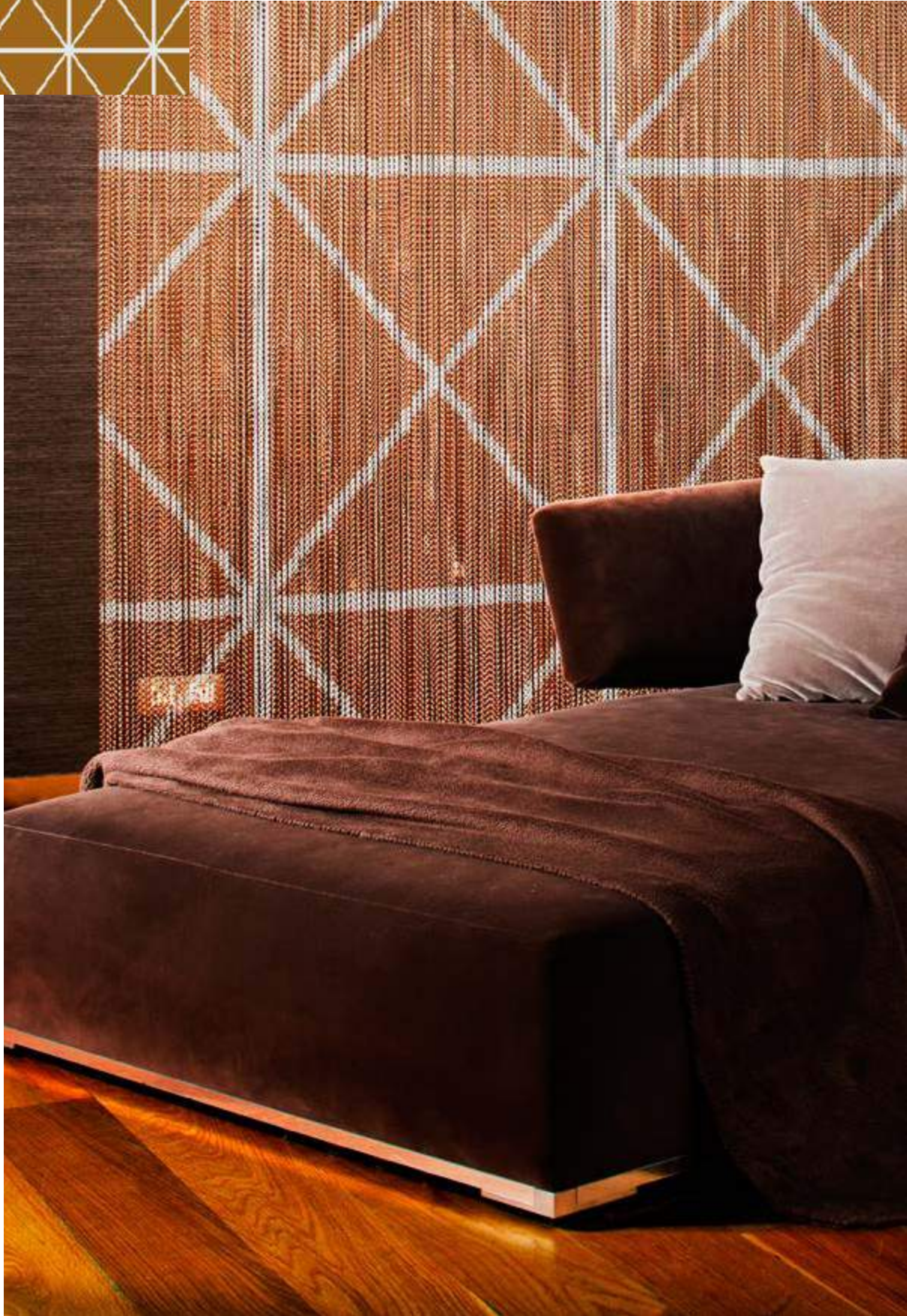
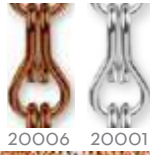
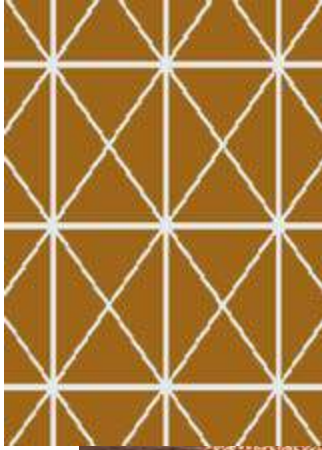



**STRIPES  
BLACK  
& GOLD**

Ref. DEC11007  
KRISKA / SNINA  
0,90 x 2,50 m  
1,35 x 2,50 m  
1,80 x 2,50 m



**STRIPES  
BLACK  
& BROWN**

Ref. DEC11005  
KRISKA / SNINA  
0,90 x 2,50 m  
1,35 x 2,50 m  
1,80 x 2,50 m

**BALDOSA  
BLUE**

Ref. DEC11038  
SNINA  
1,35 x 2,50 m



**BALDOSA  
SOFT PINK**

Ref. DEC11009  
SNINA  
1,35 x 2,50 m

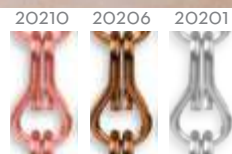



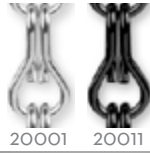

**EXPLOSION**  
 Ref. DEC11012  
 SNINA  
 1,80 x 2,50 m



20201 20212 20221 20206 20211



**WOODY**  
 Ref. DEC11039  
 SNINA  
 1,35 x 2,50 m

**BIG  
KALEIDOSCOPE**

Ref. DEC11042  
SNINA  
1,80 x 2,50 m

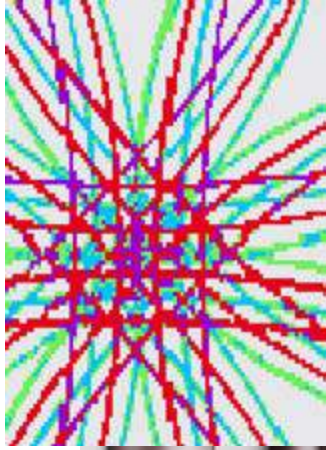

**KALEIDOSCOPE**

Ref. DEC11019  
SNINA  
0,90 x 2,50 m  
1,80 x 2,50 m

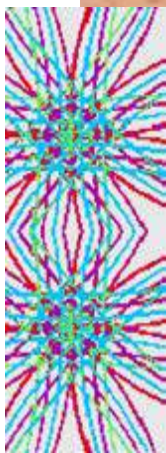

## MAINTENANCE AND TECHNICAL INFORMATION

### NOTE

Patterns can be slightly customizable in colour and size under request. Colours may vary between the catalogue and the final product supplied due to lighting effects or the printing process of the catalogue.

### INSTALLATION

The material is delivered ready for its installation, at the requested size, including rail and anchoring plates. The installation is quite easy and does not require any specialized personnel. It is only necessary to have some basic tools and to follow the included installation instructions (according to the type of anchoring requested, wall or ceiling). Before installation, it should be checked if the wall or ceiling can support the weight of the material. A square meter of chains weights 3 Kg approximately.

### SIZES

The measures of the chains are expressed in meters, indicating first the width and then the height (width x height). The height includes the rail and anchoring plates. The measures can vary slightly, due to the limitations of the chain link, but will never be larger than indicated. In order for the chains to hang freely, we recommend to leave a space of approximately 2cm between the lower part of them and the floor.

### LINKS

KRISKA - Classic link, suitable for the majority of applications. Resistant.

SNINA - Small link that permits a greater definition in designs of reduced dimensions and rounded contours.

### MATERIAL

The chains are made with 100% anodized aluminium, fully recyclable material. Due to the special anodizing process, the chain has a higher hardness and high resistance to climatic factors, friction and oxidation, which allows its use in interior and exterior.

### CLEANING

Kriskadecor chains can be cleaned with neutral, non-basic soap and water. The chain can also be cleaned using steam or pressurized water machines. To do this, the chains should be lifted, placed in a container with water and hung again once cleaned.

## INFORMACIÓN TÉCNICA Y MANTENIMIENTO

### NOTA

Los diseños pueden personalizarse ligeramente en color y medida bajo petición. Los colores pueden variar en relación a los mostrados en este catálogo debido a la impresión y/o los posibles efectos de iluminación.

### INSTALACIÓN

El material se suministra listo para su instalación según la medida solicitada, incluyendo raíl y anclajes. La instalación es sencilla y no requiere personal especializado. Solo se precisan unas herramientas básicas de bricolaje y seguir los pasos indicados en las instrucciones de montaje que se incluyen (según el tipo de sujeción solicitada, a pared o a techo). Antes de la instalación debe comprobarse que el elemento donde se instalará el material resiste el peso de la misma. Un metro cuadrado de cadena pesa 3 Kg aproximadamente.

### MEDIDAS

Las medidas de las cadenas se expresan en metros, indicándose primero la anchura y a continuación la altura (ancho x alto). La altura incluye el raíl de anclaje. Las medidas pueden variar ligeramente, debido a las limitaciones de los eslabones, pero no serán nunca superiores a las indicadas. Para una mejor caída de la cadena, recomendamos dejar un espacio libre de 2 cm aproximadamente en la parte inferior.

### ESLABONES

KRISKA - Eslabón clásico resistente y adecuado para la mayoría de aplicaciones.

SNINA - Pequeño eslabón que permite mayor definición en diseños de reducidas dimensiones y contornos redondeados.

### MATERIAL

Las cadenas se fabrican 100% con aluminio anodizado, material completamente reciclable. El proceso de anodizado especial para eslabones aporta una mayor dureza y alta resistencia a los factores climáticos, al rozamiento y la oxidación, lo que permite su uso en interior y exterior.

### LIMPIEZA

Las cadenas Kriskadecor se pueden limpiar con agua y jabón neutro, no básico. También puede utilizarse vapor o máquinas de agua a presión. Para ello, se puede descolgar la cadena, introducirla en un recipiente con agua y volver a colgarla una vez limpia.

## KRISKA

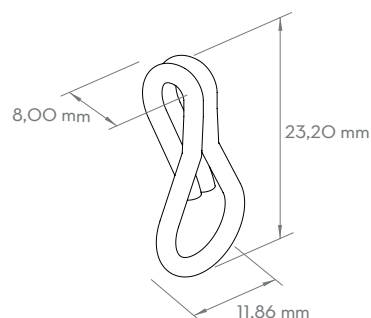

## SNINA

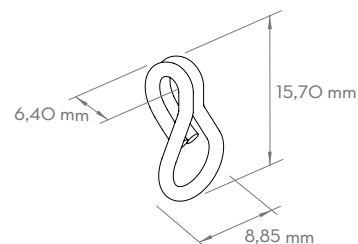



[www.kriskadecor.com](http://www.kriskadecor.com)  
[info@kriskadecor.com](mailto:info@kriskadecor.com)

Kriskadecor	Kriskadecor USA
Ctra. Rojals km 0.05	6501 E Greenway Pkwy
43400 Montblanc	Suite 103 - 346
Tarragona, Spain	Scottsdale, AZ 85254

designed by Hausner Studio